

מפרט טכני מק"ט: T90092.30

גלגל בודד (4 יח' בסט)
משקל כנף עד 30 ק"ג

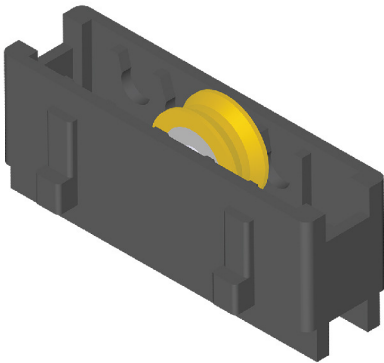

כמות יחידות באריזה

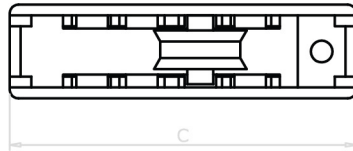

משקל

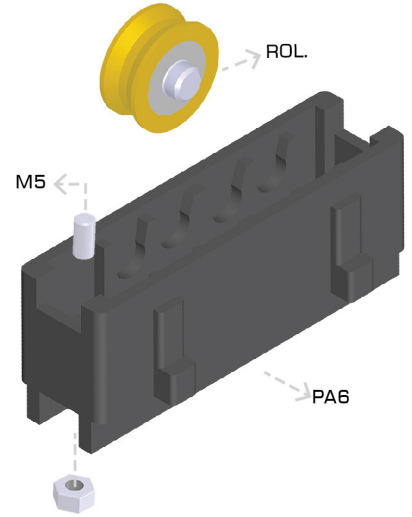
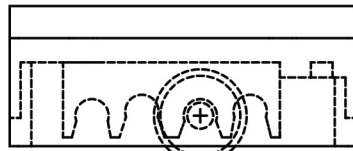

מערכות



K7300 / K7500 / N22 / B22
Specifications
Ball Bearing Roller 1 Track Tempered

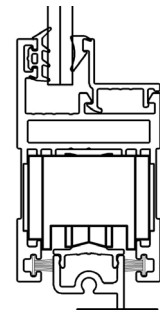
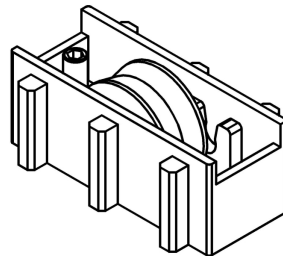
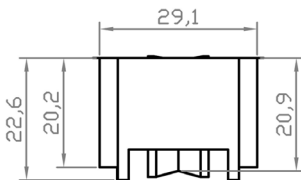

Note: In order to function properly under more extreme conditions, like salinity or high levels of humidity, the roller must be very well lubricated with extra mounting grease because the standart lubrication is for regular use. The performance of the product is assured when maintaining the conditions described in the certified laboratory test report

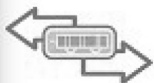

Durability test:

Performed in round-trip sliding movements over a distance of 800 mm for a total of 25,000 cycles at a speed of 4 cycles / min



Static load at room temperature, carried out for 240 hours, with the required weight



The responsibility of Technica S.M. LTD ceases when:

- The bearings are not properly handled, stored and / or installed
- Do not fulfill the load per sheet, recommended in our catalogs and datasheets
- There is no proper technical use of the bearings

Technica S.M. LTD is not responsible for any damages resulting from products that have been modified, and /or adapted, after commercialization



Polismar products are developed according to processes and procedures implemented by the quality management system according to ISO 9001: 2015